

# RTS Tilt WireFree™ Programming & Operation Instructions

## New & Improved w/RTS

WireFree™ Tilt now joins the Somfy RTS motor offering.

### Before you begin

Motors are shipped without limit switch settings and transmitter ID's. Steps (1-6) must be completed to ensure proper shade programming and functionality. Power should **ONLY** be connected to current shade being programmed. All other shades should be disconnected from their respective power while programming is in progress. While programming (step 4), shade should not be inactive for longer than 2 minutes or motor will exit programming mode.



## Programming Instructions are for use with Telis 1&4, Decora 1&4, Modulis or Chronis Timer

The following illustrations and instructions represent the Telis hand-held remote, and may also be applied to the Decora wireless wall switch and Chronis Timer.

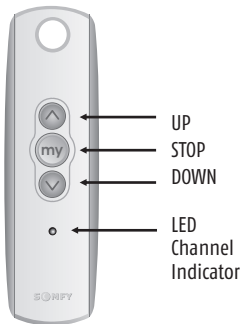

Telis RTS Single Channel (Standard)

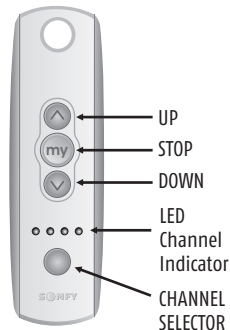

Telis RTS Five Channel (Standard)



Telis Modulis Five Channel (with tilt wheel)

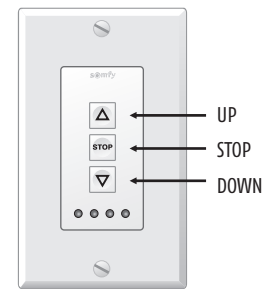

Decora WireFree Wall Switch (Standard)

## STEP ONE

### Connect Power to Motor

- 1) Connect 12V battery wand or transformer to the motor. Motor should already be installed in blind.

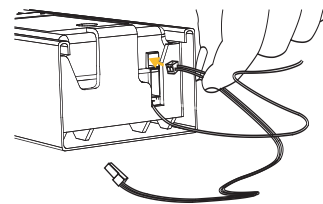

## STEP TWO

### Initiate Programming – (for use with Telis 1 & 4, Decora 1 & 4, Modulis or Chronis Timer)

#### For Single Channel Transmitters (Telis 1, Decora 1, Modulis or Chronis Timer)

- 1) On the transmitter, press and hold the **UP** and **DOWN** buttons simultaneously until the blind jogs (blind slats have a short up and down tilt movement).

#### For Multi-Channel Transmitters (Telis 4, Decora 4)

- 1) Using the channel selector, select the desired channel.
- 2) On the transmitter, press and hold the **UP** and **DOWN** buttons simultaneously until the blind jogs.

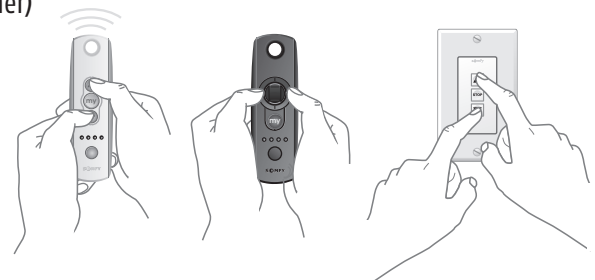

**NOTE:** This step cannot be performed if the transmitter has already been programmed (memorized) to blind.

# Tilt WireFree™ RTS Programming & Operation Instructions

## STEP THREE Check Polarity (blind direction) MUST BE DETERMINED BEFORE SETTING BLIND LIMITS

Press and hold the **DOWN button** and confirm the blind tilts down.  
 Press and hold the **UP button** and confirm the blind tilts up.

- If blind direction is correct, continue to Step 4.
- If blind direction is not correct (in reverse), press and hold the **MY (Stop) button** on the transmitter for 2 seconds. Blind will jog. Blind direction is now corrected. Blind movement should now correspond to the direction button on the transmitter.

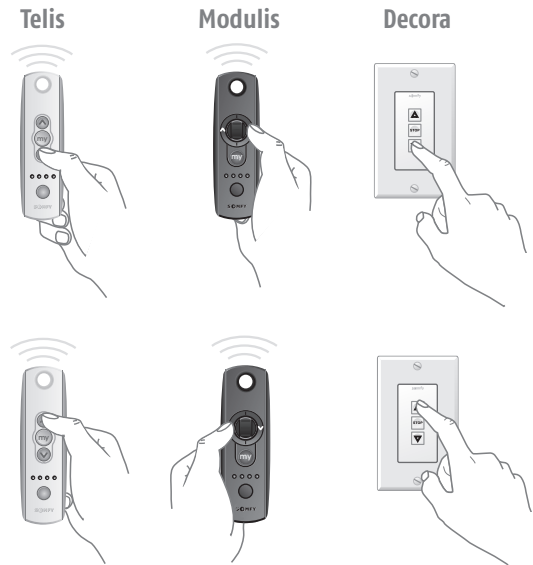

## STEP FOUR Setting Limits (Slat Positions)

Starting with slats in down (closed) position.

- 1) Press and hold the **UP or DOWN button** on the transmitter to reach the desired lower limit (slat position).

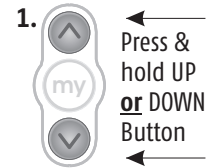
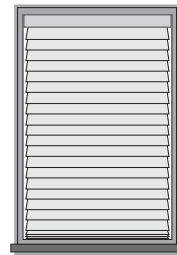

- 2) Once the desired lower limit (slat position) is reached, press and hold the **MY (Stop) and UP buttons** simultaneously until the blind begins to tilt upward, then release.

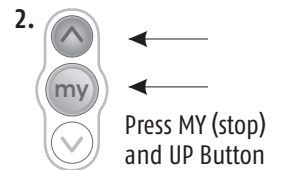

- 3) Press the **MY (Stop) button** when the blind reaches the desired upper limit (slat position). If necessary, adjust the desired slat position with a brief press of either the **UP or DOWN button**.

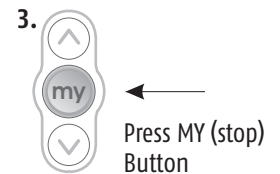

- 4) Once desired upper limit (slat position) is reached, press and hold the **MY (Stop) and DOWN buttons** simultaneously until the blind begins to tilt downward, then release.

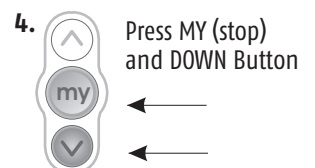

# Tilt WireFree™ RTS Programming & Operation Instructions

- 5) Once blind stops at previously set lower limit (slat position), press the **MY (stop) button** for 2 seconds until the slats jog. This confirms both limits (slat positions).

To complete programming, proceed to **STEP FIVE**

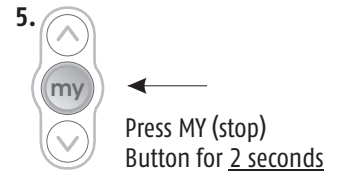

## Starting with slats in up (closed) position

- 1) Press and hold the **DOWN or UP button** on the transmitter to reach the desired upper limit (slat position).

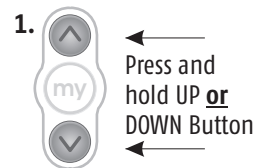
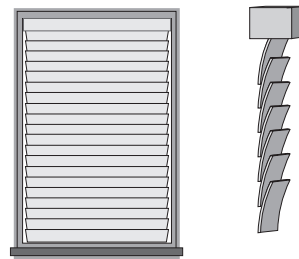

- 2) Once the desired upper limit (slat position) is reached, press and hold the **MY (Stop)** and **DOWN buttons** simultaneously until the blind begins to tilt downward, then release.

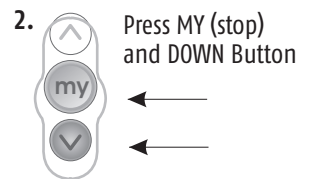

- 3) Press the **MY (Stop) button** when the blind reaches the desired lower limit (slat position). If necessary, adjust the desired slat position with a brief press of either the **UP or DOWN button**.

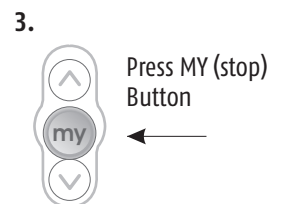

- 4) Once desired lower limit (slat position) is reached, press and hold **MY (Stop)** and **UP buttons** simultaneously until the blind begins to tilt upward, then release.

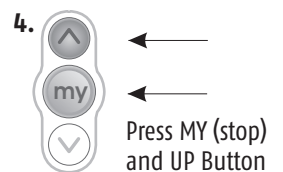

- 5) Once blind stops at previously set upper limit (slat position), press the **MY (stop) button** for 2 seconds until the slats jog. This confirms both limits (slat positions).

To complete programming proceed to **STEP FIVE**

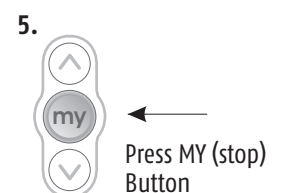

# Tilt WireFree™ RTS Programming & Operation Instructions

## STEP FIVE

### Completing & Exiting Programming Mode

Using a paperclip or pen, press and hold the **PROGRAM button** on the back of the transmitter until the blind jogs. TRANSMITTER IS NOW MEMORIZED AND PROGRAMMING IS COMPLETE.

**Note:** If power is disconnected from blind before Step 5 is completed, TRANSMITTER WILL NOT BE MEMORIZED to the programmed blind however limits (slat positions) will remain programmed. If this occurs, go back and repeat step 2 (Initiate Programming). Then omit step 4 (Setting Limits) and resume with step 5.

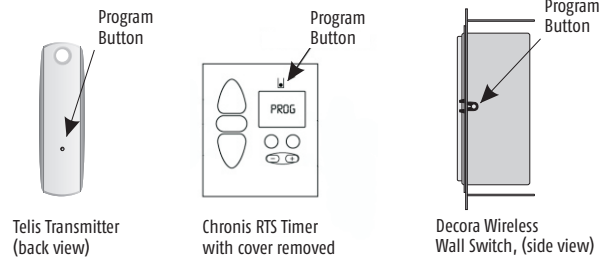

## STEP SIX

### Adding Additional Transmitters or Assigning Channels

#### Adding Additional Transmitters (Single Channel)

- 1) Using a paperclip or pen, press and hold the **PROGRAM button** on the previously addressed transmitter until the blind jogs.
- 2) Using a paperclip or pen, press and hold the **PROGRAM button** on the Additional (new) transmitter until the blind jogs. Additional (new) transmitter is now added to shade memory and can be used to operate blind.

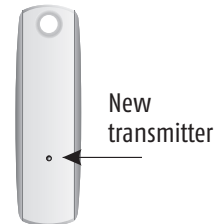
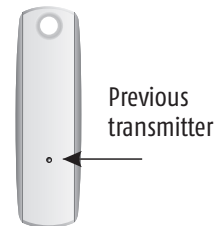

#### Assigning Specific Channels to Blind (Multi-channel transmitters only)

- 1) Using a paperclip or pen, press and hold the **PROGRAM button** on the previously addressed transmitter until the blind jogs.
- 2) Select the desired channel (1-4 or all) by momentarily pressing the **Channel Selector Button** on the multi-channel transmitter.
- 3) Press and hold the **PROGRAM button** on the multi-channel transmitter until the blind jogs. Additional (new) channel is now added to blinds memory and can be used to operate blind.

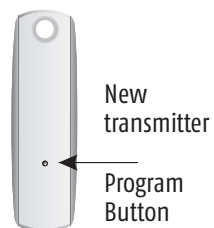

**Note:** To prevent unwanted Channel/Transmitter assignments, ALL PREVIOUSLY PROGRAMMED BLINDS should be UNPLUGGED until Programming is complete.

# Tilt WireFree™ RTS Programming & Operation Instructions

## Deleting Specific Channels/Transmitters

- 1) Using a paperclip or pen, press and hold the **PROGRAM button** on the previously addressed transmitter until the blind jogs.
- 2) Select the desired channel (1-4 or all) or transmitter (single channel) to be deleted.
- 3) Press and hold the **PROGRAM button** on the transmitter until the blind jogs. Channel or transmitter is now deleted from the blind memory and will not operate blind.



## STEP SEVEN

### Resetting Motor (Erasing all Previously Programmed Limit Settings and Channels)

- 1) **To delete ALL transmitter channels:** Using a paperclip, press and hold the **PROGRAM button** located on the motor head until LED light begins to flash on and off, release button and blind will jog.
- 2) **To delete all previous settings:** Using a paperclip, press and hold the **PROGRAM button**, located on the motor head for 12 seconds. All transmitters and limits will be erased. (Motor is now reset to factory mode.) Motor limits will need to be reestablished.

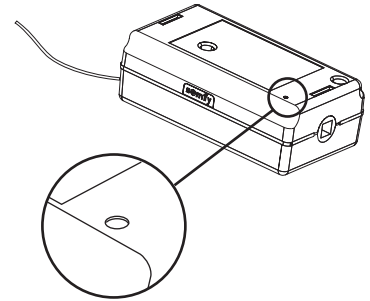

## OPTION ONE

### Setting an Intermediate Position (IP)

- 1) Press the **UP or DOWN** directional button on the previously addressed transmitter until the blind slats reach a desired intermediate position, then press the **MY (Stop)** button to stop. If necessary adjust the desired slat position by pressing and holding either the **UP or DOWN button**.

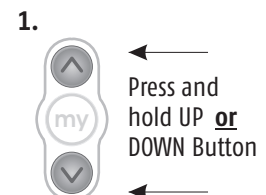

# Tilt WireFree™ RTS Programming & Operation Instructions

- 2) Press and hold the **MY (Stop)** button on the transmitter until the blind jogs. Intermediate slat position is now added to memory

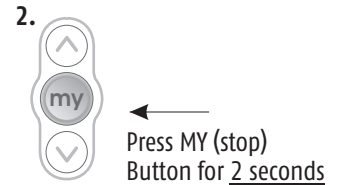

- 3) Activate the blind intermediate position by pressing the **MY (Stop) button** from ANY slat position.

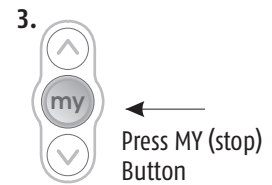

**Note:** Blind should be stationary prior to activating intermediate position function. If slats are actively moving (in-motion) the MY (Stop) button should be pressed twice.  
**To Delete:** Activate blind to (IP) position, then press and hold the MY (Stop) button for 5 seconds.

## OPTION TWO

### Re-adjusting Upper Limit (UP Slat Position)

- 1) Press the **UP directional button** on the transmitter. Blind will tilt to the pre-set UP limit.

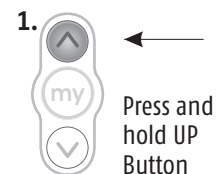

- 2) Once blind stops at pre-set up limit, press and hold the **UP and DOWN buttons** simultaneously on the transmitter until the blind jogs.

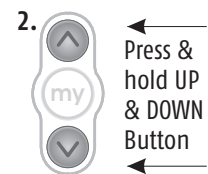

- 3) Press and hold either the **UP or DOWN button** on the transmitter to adjust slats to new position.



- 4) Press and hold the **MY (Stop) button** until the blind jogs. New Upper Limit (Up Stop Position) is now added to memory.

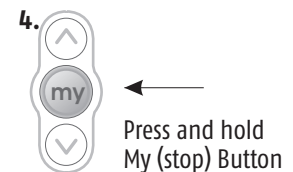

# Tilt WireFree™ RTS Programming & Operation Instructions

## OPTION THREE Re-adjusting Lower Limit (DOWN Slat Position)

1) Press the **DOWN** directional button on the transmitter. Blind will tilt to the pre-set **DOWN** limit.

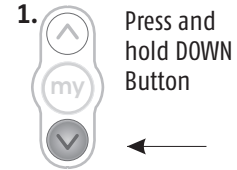

2) Once blind stops at pre-set down limit, press and hold the **UP and DOWN buttons** simultaneously on the transmitter until the blind jogs.

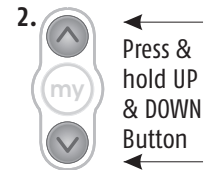

3) Press and hold either the **UP or DOWN button** on the transmitter to adjust slats to new position.

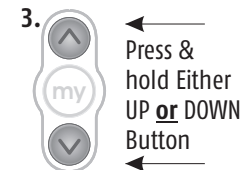

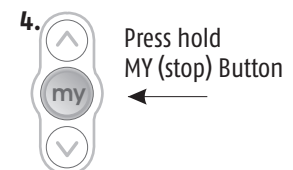

4) Press and hold the **MY (Stop) button** until blind jogs. New lower limit (Down Stop Position) is now added to memory



## Operating Instructions are for use with Telis 1&4, Decora 1&4 or Modulis Chronis Timer



### USER MODE: Operating the Blind (tilting the slats)

#### Telis & Decora Switch Only

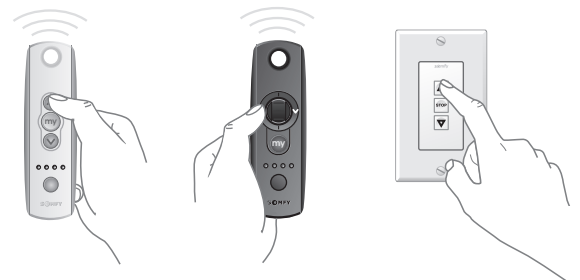
1. Press and hold the (UP)  button to open the blind slats. Release the button when the desired position is reached. Blind slats will operate at 1/2 speed **or** press momentarily on the UP  button, blind slats will move to the programmed limit (slat position) at full speed.



#### Telis & Decora Switch Only

2. Press and hold the (DOWN)  button to close the slats. Release the button when the desired position is reached. Blind slats will operate at 1/2 speed **or** press momentarily on the DOWN  button, blind slats will move to the programmed limit (slat position) at full speed.

# Tilt WireFree™ RTS Programming & Operation Instructions

## **Modulis Only**

Press momentarily on the (UP) ▲ button to open the blind slats. Press the (UP) ▲ button again to stop the movement of the slats. (If the stop command is not desired, slats will continue to move to the preprogrammed limit (slat position))



## **Modulis Only**

Press momentarily on the (DOWN) ▼ button to close the slats. Press the (DOWN) ▼ button again to stop the movement of the slats. (If the stop command is not desired, slats will continue to move to the preprogrammed limit (slat position))



## Using the Scroll Wheel

### **Modulis Only**

3. Scroll the wheel of the Modulis transmitter to move the blind slats up or down. The slats will move in relation to the motion of the wheel on the transmitter.



## Activate the Preferred Position

### **Telis, Modulis & Decora Switch**

4. Press momentarily on the  MY (stop) button. The slats will start moving and stop at the pre-programmed  "preferred" slat position.

